

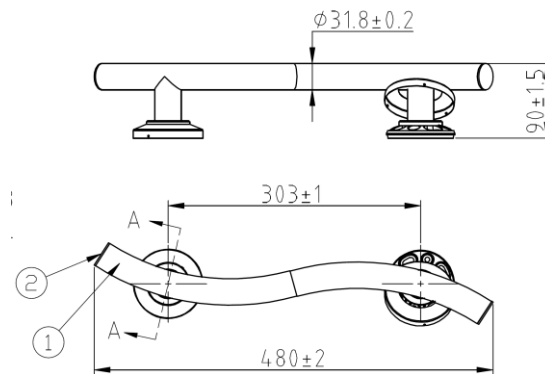

## PRODUCT DATA SHEET

### GR-18/CU/SSP

*480mm curved polished stainless steel grab rail with concealed fixings*



#### DIMENSIONS:

Tube diameter	32 mm
Total projection from wall	90 mm
Total length	480 mm
Flange diameter	84 mm

#### MATERIALS:

Grade 304 stainless steel

#### FINISH:

Mirror polished

#### FIXING POINTS:

8 x 8 mm diameter holes per flange