

impey

# Accessible Showering Additions

Comfort for everyone.



October 2024

**Market leader  
for a generation**

Our core mission has always been to provide better showering options for all. Our wetroom system continues to lead the market with unmatched performance and lifetime guarantees.

## Further showering comfort

Historically, accessible bathroom fittings have been limited in both variety and design appeal. Our in-house product designers collaborate closely with accessibility experts to create solutions that seamlessly blend style and functionality, dispelling the myth that accessibility has to compromise on aesthetics.

---

### Contents

---

02—09	<b>Introduction to Impey</b>
10—13	<b>Boston Comfort &amp; Safety Accessories</b>
14—17	<b>Maxi-Grip Grab Rails</b>
18—21	<b>SlimFold Shower Seats</b>
22—27	<b>Elevate Half Height Doors</b>
28—33	<b>Supreme Glass Screens</b>
34—39	<b>Curtains, Screens &amp; Waste Pumps</b>

---

## Reasons to choose Impey

**We are immensely proud of our highly experienced support team and our market leading product range.**

Our expanding portfolio of innovative award-winning accessible showering products offers the chance to create elegant and ergonomic shower spaces.

Market-leading wetroom floor formers, half height shower doors, multi-function grab rails, glass screens that provide space and dignity and shower seats with colour and shape variation.

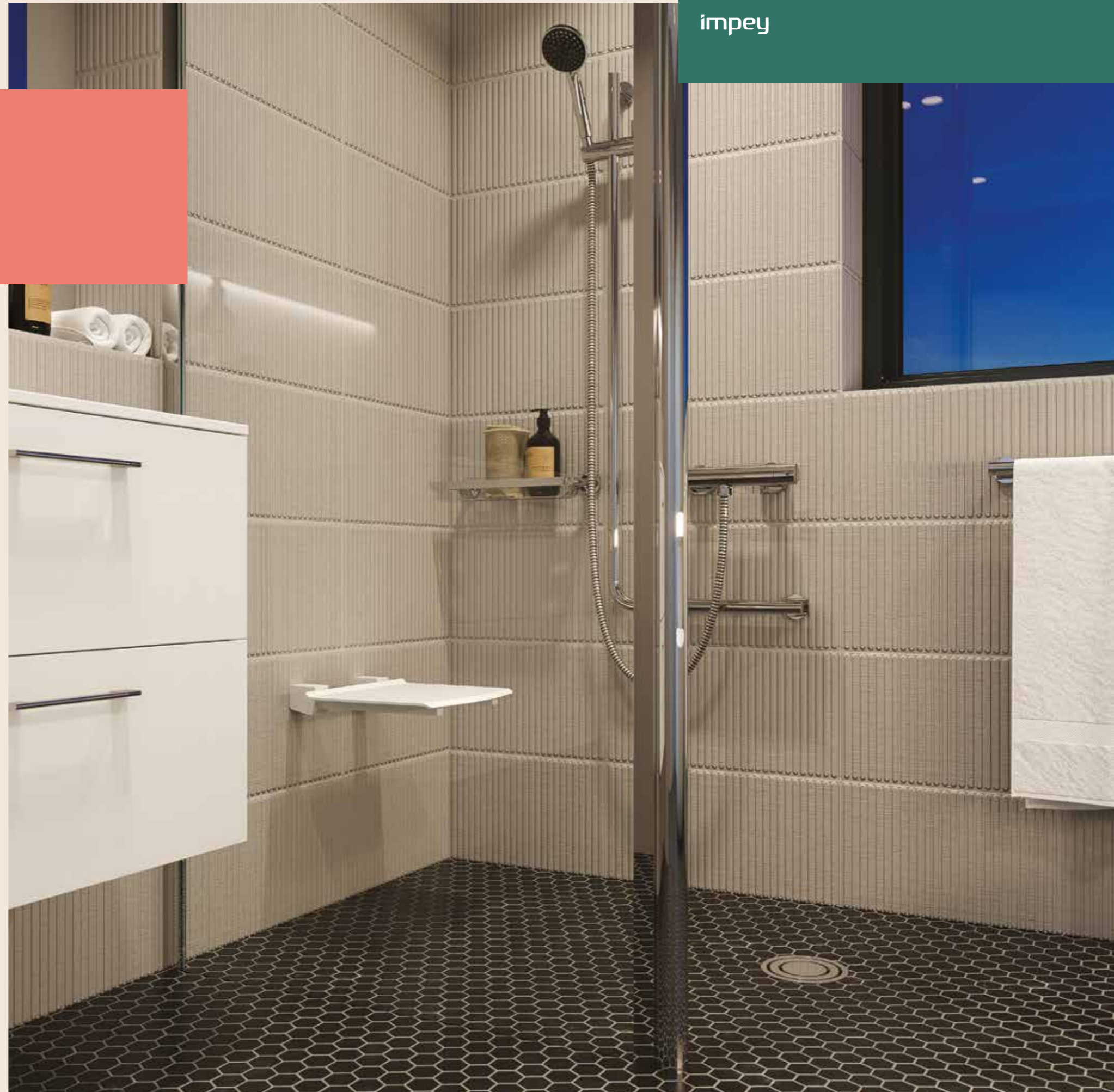

## In-house Innovation

### Leading the way in innovation for wetrooms and accessible bathrooms.

Innovations are embedded in every design across the Impey portfolio. We redefine what is possible, add value and bring unprecedented benefits to the installer and user.

Combining enhanced functionality and improved performance with stylish and contemporary design, we make it easy to create tailored showering spaces that are modern, attractive and cater to personal requirements.

Across our product ranges, the best materials and rigorous construction methods are utilised, to ensure the very highest level of quality and reliability.



## Proud UK Manufacturer

As a UK-based manufacturer, we are proud to employ a local workforce.

Each Impey product is made with the highest levels of care and attention to detail.

At our manufacturing site in Bridgnorth, Shropshire, we use streamlined, modern manufacturing processes to ensure that all our products are of unparalleled quality and produced as efficiently as possible.

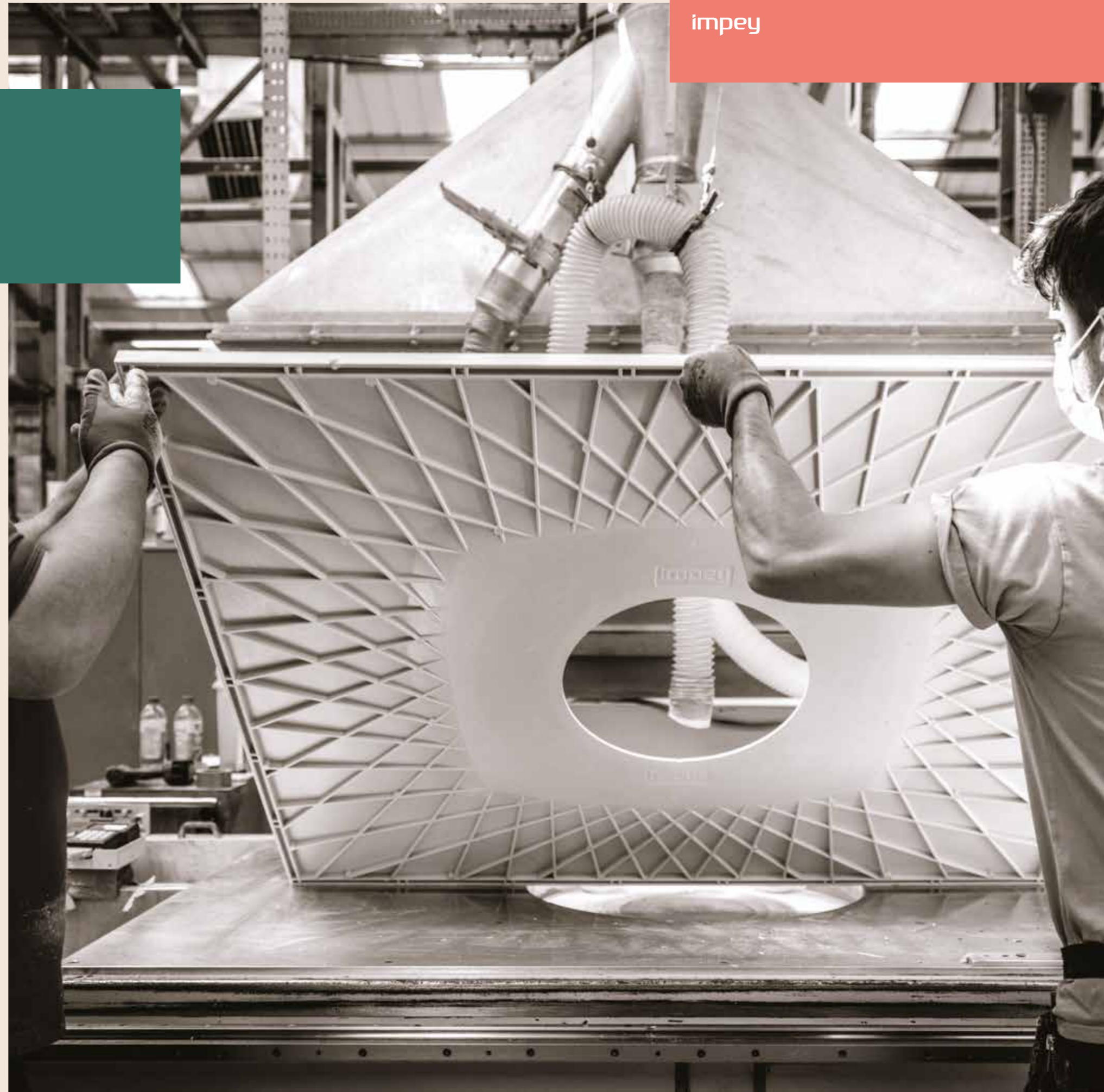

# Boston Comfort & Safety Accessories

Crafted from stainless steel with a choice of polished or brushed finish.

**Practical  
& Personal**

**Form  
& Function**

Designed to update and enhance bathrooms for independent living, this range is focused on providing discreet assistance and support.

## Key Benefits

- Choice of brushed or polished finish
- Made from high quality stainless steel
- Concealed fittings: no visible mounting hardware after installation
- Ergonomic design
- Tested and approved in accordance with the most recent TÜV standards
- Easy to install and easy to clean
- Weight load tested
- Mounting hardware for concrete walls included

# Accessorising your shower space

The Boston Comfort & Safety range enables you to complete your wetroom look with stylish living accessories, including a variety of brushed and polished stainless steel accessories, providing a safe bathroom environment for those who do not wish to compromise on style.

## Key Benefits

- Load bearing up to 150kg (23 stone)\* tested by TÜV
- 25mm in diameter
- CE Compliant



### Shower Seat

Code	Description	Price Ex. Vat	Price inc. VAT
299520346	Boston Comfort & Safety Shower Seat	£202.57	£243.08

\*up to 120kg (18 stone) for Shower Seat



### Shower Seat White

Code	Description	Price Ex. Vat	Price inc. VAT
915819-02	Boston Comfort & Safety Shower Seat	£175.30	£210.36

\*up to 120kg (18 stone) for Shower Seat



Right hand shown

### Safety Grab Bar / Toilet Roll Holder 135°

Code	Description	Price Ex. Vat	Price inc. VAT
Stainless Steel			
299120946	Left brushed	£112.05	£134.46
299120346	Left polished	£115.94	£139.13
299150346	Right brushed	£112.05	£134.46
299150946	Right polished	£115.94	£139.13



Right hand shown

### Safety Angled Grab Bar 135°

Code	Description	Price Ex. Vat	Price inc. VAT
Stainless Steel			
298720946	Left brushed	£124.82	£149.78
298720346	Left polished	£131.87	£158.24
298750946	Right brushed	£124.82	£149.78
298750346	Right polished	£115.94	£139.13



### Safety Grab Bar - straight (3 sizes)

Code	Description	Price Ex. Vat	Price inc. VAT
Stainless Steel			
297720946	30cm brushed	£58.35	£70.02
297720346	30cm polished	£61.43	£73.72
297920946	45cm brushed	£62.62	£75.14
297920346	45cm polished	£65.72	£78.86
298120946	90cm brushed	£95.85	£115.02
298120346	90cm polished	£100.24	£120.29



Left hand shown

### Shower Rail with Safety Grip Handle

Code	Description	Price Ex. Vat	Price inc. VAT
Stainless Steel			
299720946	left brushed	£172.71	£207.25
299720346	left polished	£173.20	£207.84
299750946	right brushed	£172.71	£207.25
299750346	right polished	£173.20	£207.84



### Anti Slip Grip Grey

Code	Price Ex. Vat	Price inc. VAT
297521046	£18.78	£22.54



### Folding Grab Bar

Code	Description	Price Ex. Vat	Price inc. VAT
Stainless Steel			
299230346	polished	£244.14	£292.97

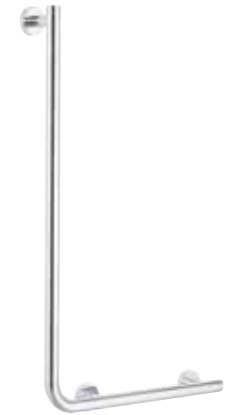

Right hand shown

### Safety Bar 90°

Code	Description	Price Ex. Vat	Price inc. VAT
Stainless Steel			
298320946	left brushed	£134.43	£161.32
298320346	left polished	£140.87	£169.04
298350946	left brushed	£134.43	£161.32
298350346	left polished	£140.87	£169.04



### Toilet Brush and Holder

Code	Description	Price Ex. Vat	Price inc. VAT
Stainless Steel			
299920946	brushed	£77.88	£93.46
299920346	polished	£83.03	£99.64



### Organiser grey

Code	Price Ex. Vat	Price inc. VAT
297621046	£24.30	£29.16



Lifetime Guarantee

# Maxi-Grip Grab Rails

The strongest, easiest to grip and most versatile hand rail system available.

## Practical & Personal

## Form & Function

Uses a square aluminium box section as reinforcement for maximum strength.

### Key Benefits

- Supports up to 150kg (23 stone)
- Options for 90°, 60°, 45° or 30° angles
- Modular kits available allowing for custom configurations
- Available in 1.8m lengths that can be cut to size
- Can be used for internal or external corners
- High quality corrosion resistant steel
- Four point wall fixing and flared brackets reduce the stress points creating a secure fixture
- Lifetime guarantee

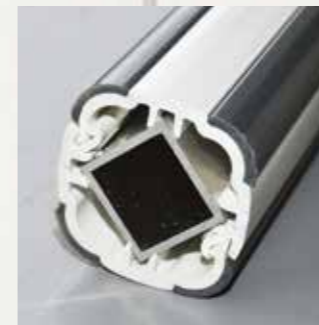

Aluminium core for maximum strength



# Maxi-Grip

The square profile of the Maxi Grip range improves slip resistance, whilst the unique co-polymer extrusion of Maxi-Grip Plus gives the corners of the rails a soft tactile quality for increased grip and comfort. Contains an aluminium core for maximum strength and can support up to 150kg (23 stone). Square design gives better grip and stops the Grab Rail from rotating.

Maxi-Grip can support loads of up to 150kg (23 stone). The range also includes options for 90°, 60°, 45° or 30° angles plus internal and external corners.

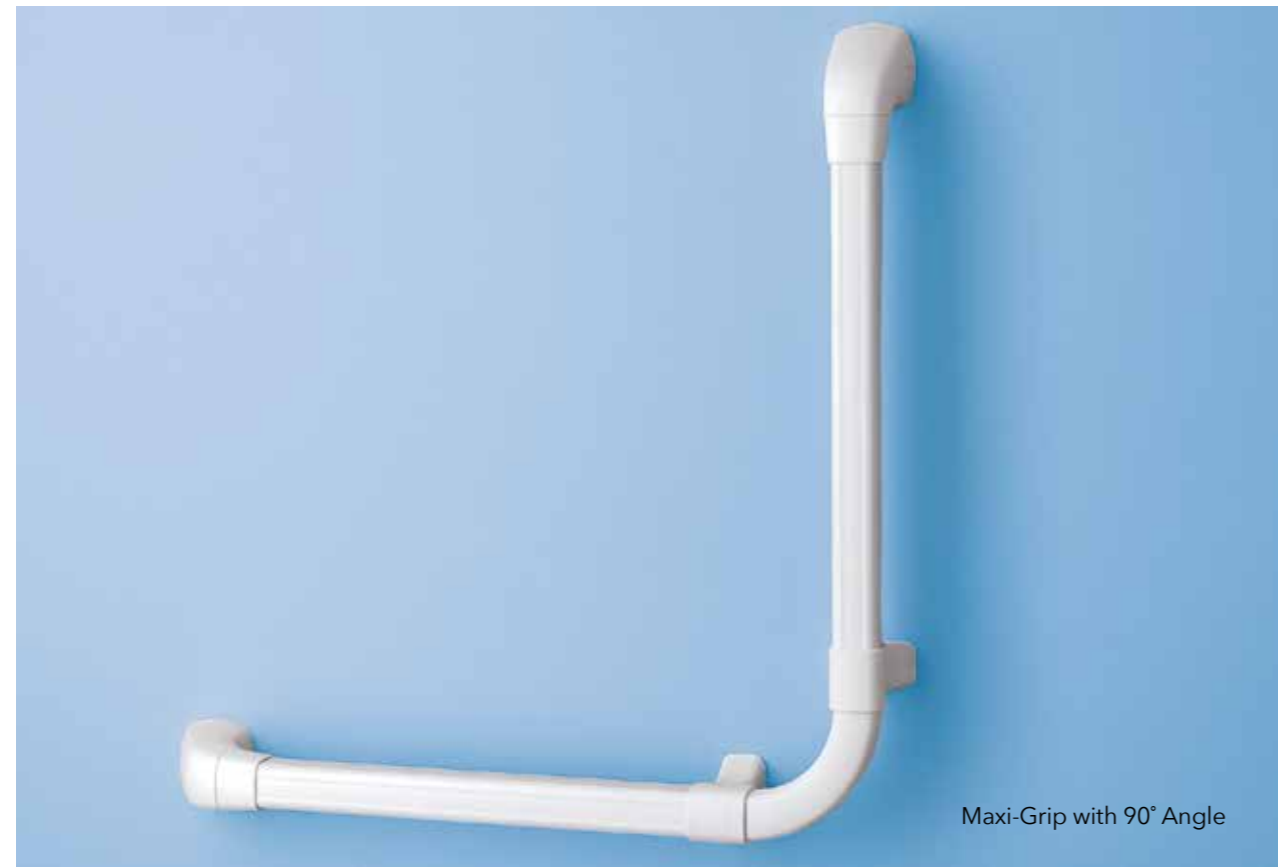

Maxi-Grip with 90° Angle

## Maxi-Grip Hand Rail (White)

Code	Size	Price Ex. Vat	price inc. VAT
IGC30W	300mm	£21.85	£26.22
IGC45W	450mm	£25.20	£30.24
IGC60W	600mm	£29.39	£35.27
IGC90W	900mm	£36.11	£43.33

## Maxi-Grip Adjustable Angle

Code	Angle	Price Ex. Vat	Price inc. VAT
IGA45W	45° White	£10.89	£13.07
IGA90W	90° White	£10.89	£13.07

# Maxi-Grip Plus

The Maxi-Grip Plus grab rails feature all the aspects of the standard Maxi-Grip range however have been further developed with the help of the RNIB to offer class leading benefits for those with sight impairment.



Maxi-Grip Plus with 45° Angle



90° Angle can be used for internal and external corners



The 90° Adjustable Angle can be trimmed to 60°, 45° & 30° and the 45° can be trimmed to 30°

## Maxi-Grip Plus Hand Rail (White/Grey)

Code	Size	Price Ex. Vat	Price inc. VAT
IGS30G	300mm	£29.31	£35.17
IGS45G	450mm	£32.54	£39.05
IGS60G	600mm	£35.64	£42.77
IGS90G	600mm	£39.92	£47.90

## Maxi-Grip Plus Adjustable Angle

Code	Angle	Price Ex. Vat	Price inc. VAT
IGA45G	45° White/Grey	£10.89	£13.07
IGA90G	90° White/Grey	£10.89	£13.07

## Maxi-Grip Plus Modular Kits

Multi-packs of rails, brackets and angles offer the ability to create customised installations that can be trimmed to size and angled on-site.

Code	Description	Price Ex. Vat	Price inc. VAT
MGRG184	MGRG184 1.8m Hand Rail: x 4	£178.74	£214.48
MGEBG4	End Brackets: x4	£7.32	£8.78
MGCG4	Trimmable Angles: x4	£43.51	£52.21



Lifetime Guarantee

# SlimFold™ Shower Seats & Benches

A shower seat is an important addition to an accessible bathroom. It's a good idea to assess the size and layout of the showering area and any individual requirements before deciding upon an option.

## Practical & Personal

## Form & Function

Our SlimFold range of seats combine high performance, a range of colours and options for varying levels of care and comfort.

### Key Benefits

- Slim design fits closely to the shower wall
- Seat only protrudes 114mm when folded
- Can support up to 300kg (47 stone)
- Hygienic and easy to clean surfaces with no dirt traps
- Seat can be mounted as low as 415mm
- Mechanism designed to easily fold down and prevents the seat from accidentally dropping down
- High quality corrosion resistant steel
- Top of the seat is angled back at 4° to allow water to run off the back.
- No drop down legs eliminates the trip risk for users and increases wheelchair turning circle options
- Rounded, smooth seats made from flexible polyethylene provide natural padding as well as being comfortable and warm to the touch
- Lifetime guarantee

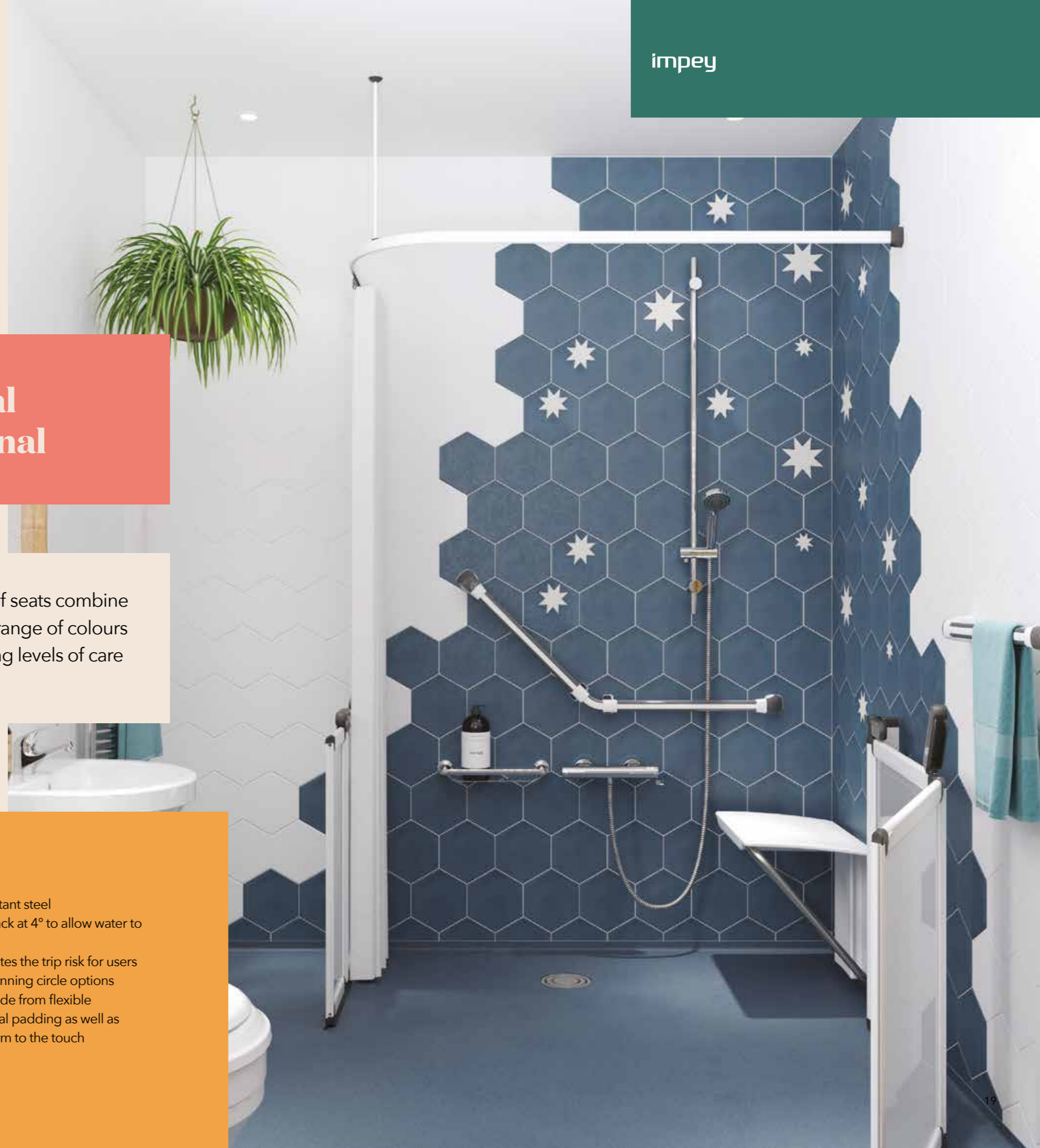

# SlimFold™ Shower Seat

When folded the seat has a projection of only 114mm, plus you see the stylish top of the seat, rather than the underside. This is also safer, because it cannot accidentally drop down if knocked. To deploy it you simply pull out the front edge so that the rear of the seat slides down and the arms then fold neatly into place.

Using cross bracing wall supports, instead of traditional floor standing legs, prevents the risk of trapping your toes or banging your feet, or of excessive weight on the legs damaging the floor. It also allows you to mount the seat as low as 415mm if required and the top is slightly angled so that water runs off the back.

The rounded and smooth seat is comfortable, feels warm to the touch and is easy to use. This revolutionary design, made in Britain using high quality corrosion resistant materials, can support up to 300kg\* (47 stone).



\*Independently tested to BS12182 and BS12727

Code	Colour	Price Ex. Vat	Price inc. VAT
SFS250WBG	Black Granite	£560.25	£672.30
SFS250WGY	Grey	£560.25	£672.30
SFS250WSB	Sky Blue	£560.25	£672.30
SFS250WSS	Sandstone	£560.25	£672.30
SFS250WWS	White Stone	£560.25	£672.30



## SlimFold Shower Seat dimensions

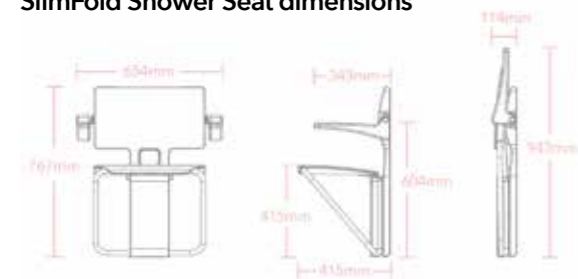

## SlimFold Seat range - fold down mechanism

To deploy it you simply pull out the front edge so that the rear of the seat slides down and the arms then fold neatly into place. The top of the seat is angled at 4° so that water runs off the back.



# SlimFold™ Shower Bench



## SlimFold Shower Bench dimensions

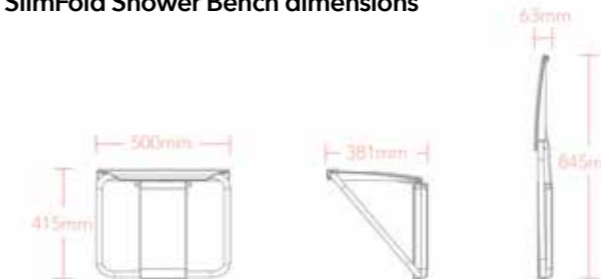

The SlimFold Shower Bench possesses all the features of the SlimFold Shower Seat in terms of colour choice, weight limit and seat folding mechanism. However due to the lack of back and arms it protrudes only 63mm from the wall when folded.

All SlimFold Shower Seat designs come as standard with White Stone wall fixed back

Code	Colour	Price Ex. Vat	Price inc. VAT
SFB250WBG	Black Granite	£333.19	£399.82
SFB250WGY	Grey	£333.19	£399.82
SFB250WSB	Sky Blue	£333.19	£399.82
SFB250WSS	Sandstone	£333.19	£399.82
SFB250WWS	White Stone	£333.19	£399.82





Lifetime Guarantee

# Elevate Half Height Doors

Half height carer doors are all about assisted showering and have evolved over the past thirty years to offer greater assistance to carers when assisting someone in the shower.

## Practical & Personal

## Form & Function

The waist height allows for easy access to any shower controls and the doors themselves guard against any unwanted water escaping when attending to those showering.

### Key Benefits

- The UK's market leading half height door
- Available in wide range of folding and sliding sizes to suit Impey wetroom floor formers
- No drilling required through the tiled or vinyl floor
- Fully enclosed hinges
- Colour contrasting design
- Tactile materials
- Average install time of 20 minutes
- User friendly paddle operation
- Serviceable parts
- Bespoke sizing available
- Lifetime guarantee

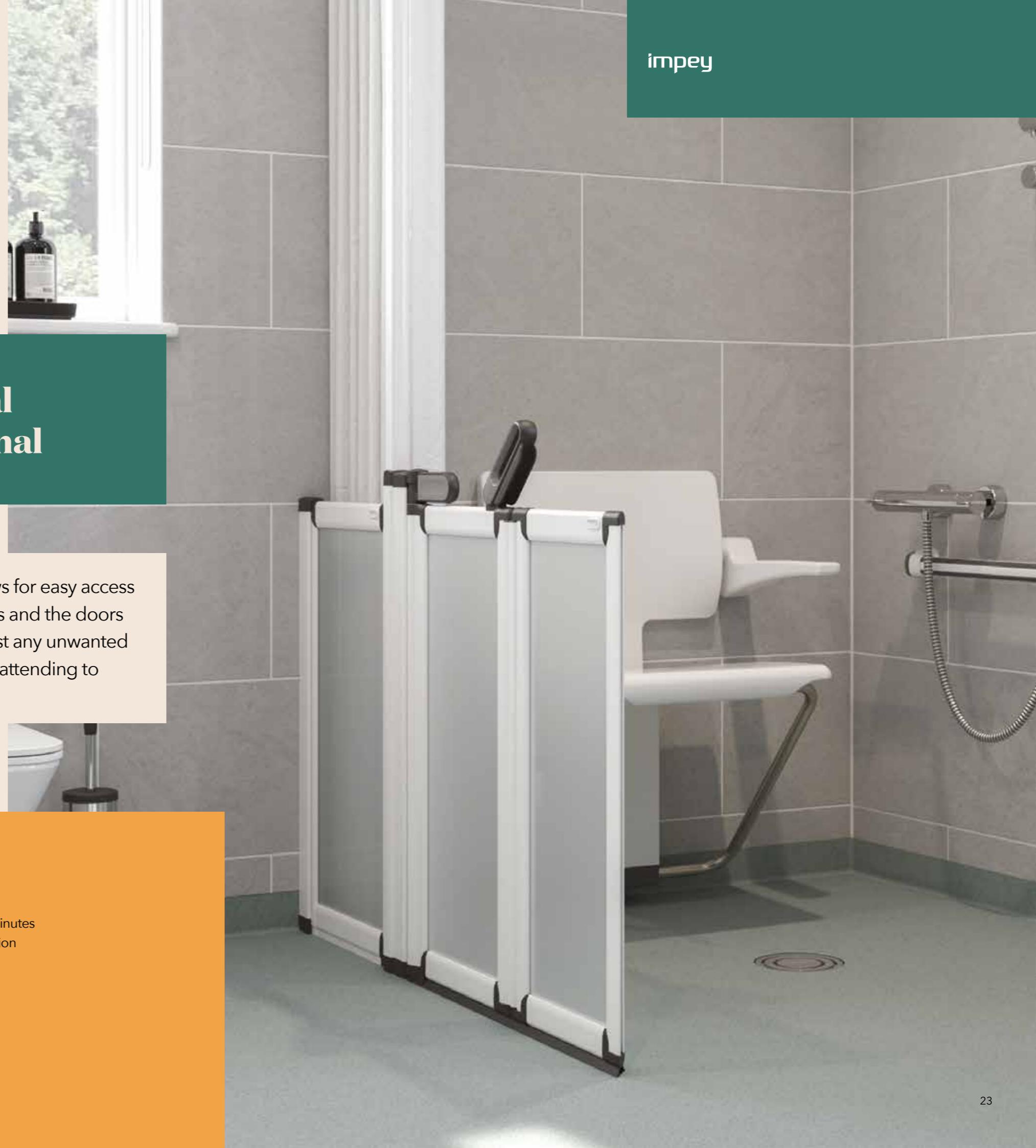

# Intuitive and easy lifting door design

UK CA CE CE tested to BS EN 14428

Elevate Bi-Fold Shower Door

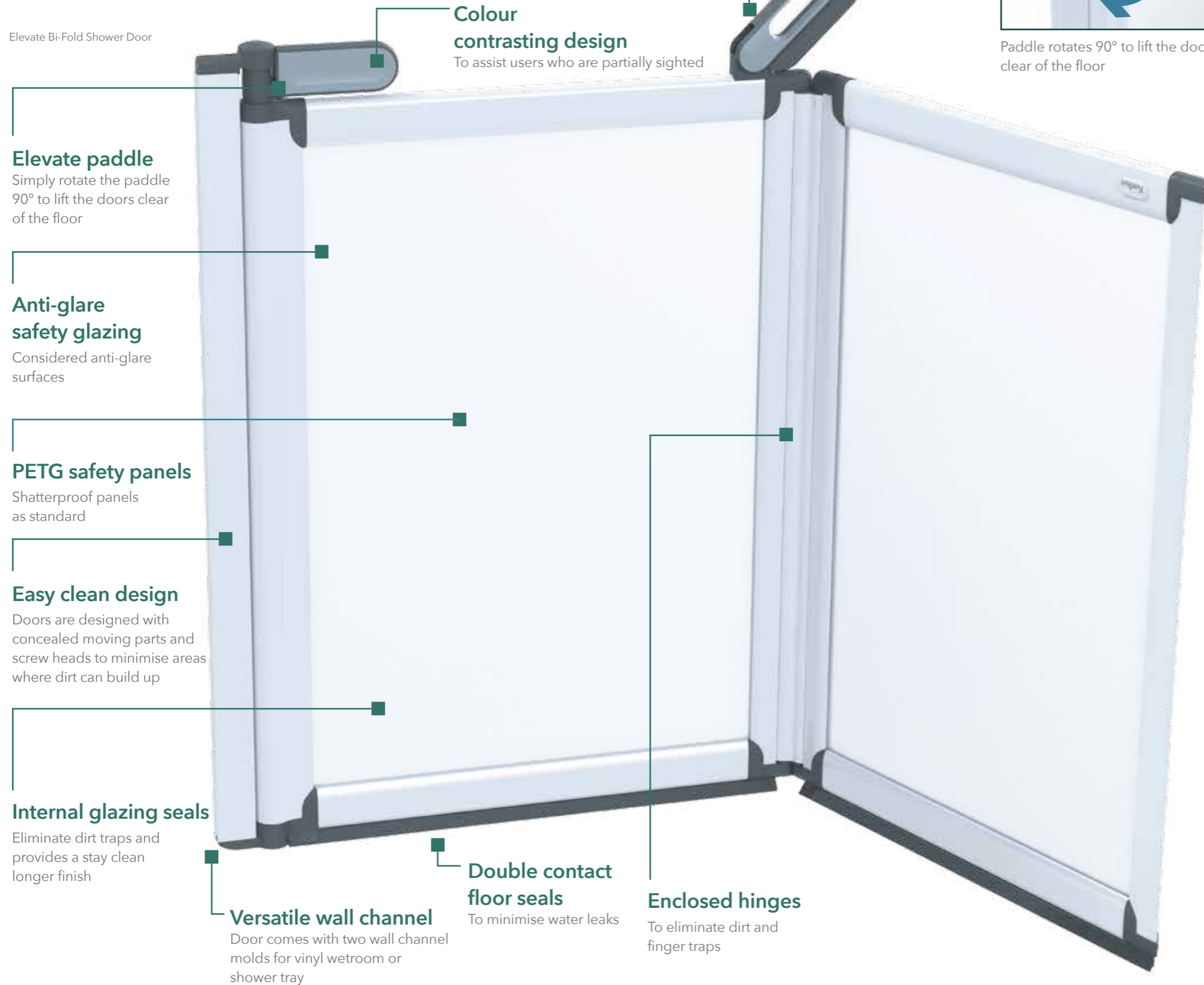

**Elevate paddle**  
Simply rotate the paddle 90° to lift the doors clear of the floor

**Anti-glare safety glazing**  
Considered anti-glare surfaces

**PETG safety panels**  
Shatterproof panels as standard

**Easy clean design**  
Doors are designed with concealed moving parts and screw heads to minimise areas where dirt can build up

**Internal glazing seals**  
Eliminate dirt traps and provides a stay clean longer finish

**Versatile wall channel**  
Door comes with two wall channel molds for vinyl wetroom or shower tray

**Easy to grasp latch handle**  
No grip required for users with limited strength or mobility by simply placing your hand through and lifting

**Colour contrasting design**  
To assist users who are partially sighted

**Double contact floor seals**  
To minimise water leaks

**Enclosed hinges**  
To eliminate dirt and finger traps

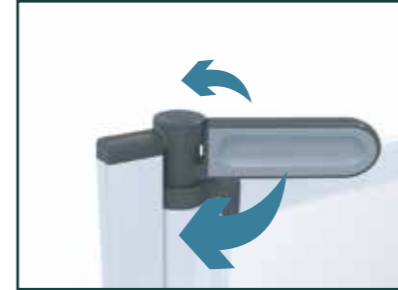

Paddle rotates 90° to lift the doors clear of the floor



Bi-Fold Door only  
Latch handle lifts up and down to lock doors into place



Bi-Fold Door only  
Bi-Fold Doors can be folded back to allow for wider opening and storage



When the door is opened, the Elevate door rises to create a 15mm gap.

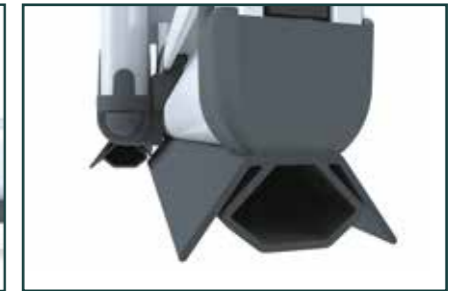

Double contact seals minimises water leaks

15mm



Elevate Sliding Shower Door

# Common corner and alcove configurations

All corner options can be supplied with L-shaped curtain rail and curtain. All door configurations are available left or right handed (left hand illustrated).

**Bespoke options available**

**Prices start from £400**

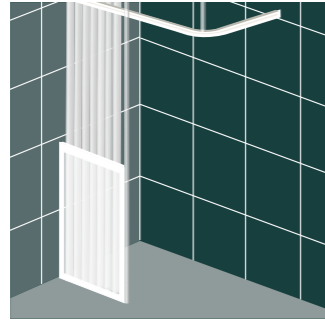

**Option C**  
Fixed 750mm wide half height fixed panel, floor to ceiling pole

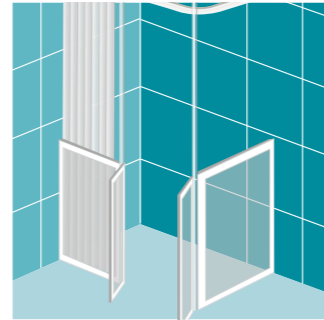

**Option D**  
Two fixed half height panels, one 400mm on front, with floor to ceiling poles on front, with one door hung from each panel



**Option E**  
400mm fixed half height panel with floor to ceiling pole and a pair of bi-fold doors meeting on corner

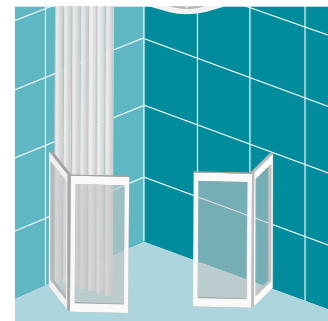

**Option H**  
Two half height bi-fold doors meeting on the corner

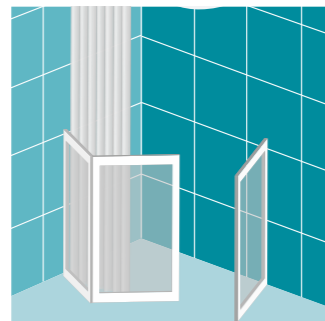

**Option J**  
One bi-fold and single door meeting on the corner



**Option 1**  
Pair of sliding doors meeting on the corner



**Option 6**  
Fixed 400mm half height panel, floor to ceiling pole with pair of sliders meeting a return pair of sliders on the corner

All alcove options can be supplied with L-shaped curtain rail and curtain. All door configurations are available left or right handed (left hand illustrated).

**Bespoke options available**

**Prices start from £400**

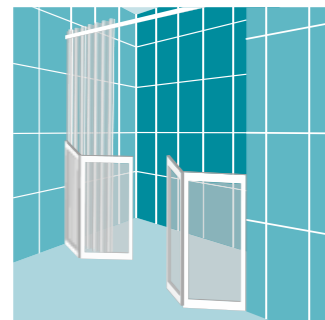

**Option G**  
Two half bi-fold doors meeting in the middle

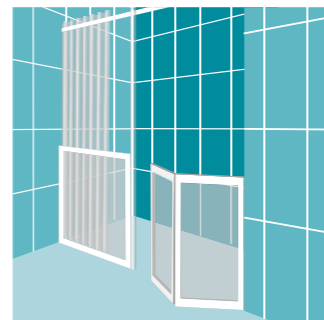

**Option M**  
One bi-fold door meeting fixed 400mm panel with floor to ceiling pole



**Option 2**  
One set of sliding doors hung off one side latching on opposite wall



**Option 3**  
One fixed half height 400mm panel with floor to ceiling pole and one sliding door hung from opposite wall



**Option 4**  
Pair of sliding doors hung between walls meeting in middle

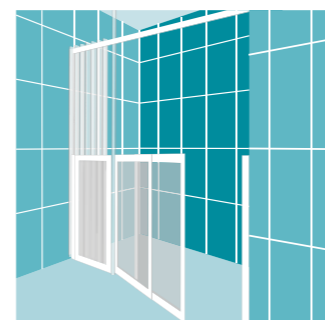

**Option 5**  
One 400mm fixed half height panel with floor to ceiling pole, one sliding door hung off pole and latching on opposite wall

## Half Height Door - handing

When working out whether the area needs a Left Handed or a Right Handed Half Height Door, it is best to refer to the roomset diagram.

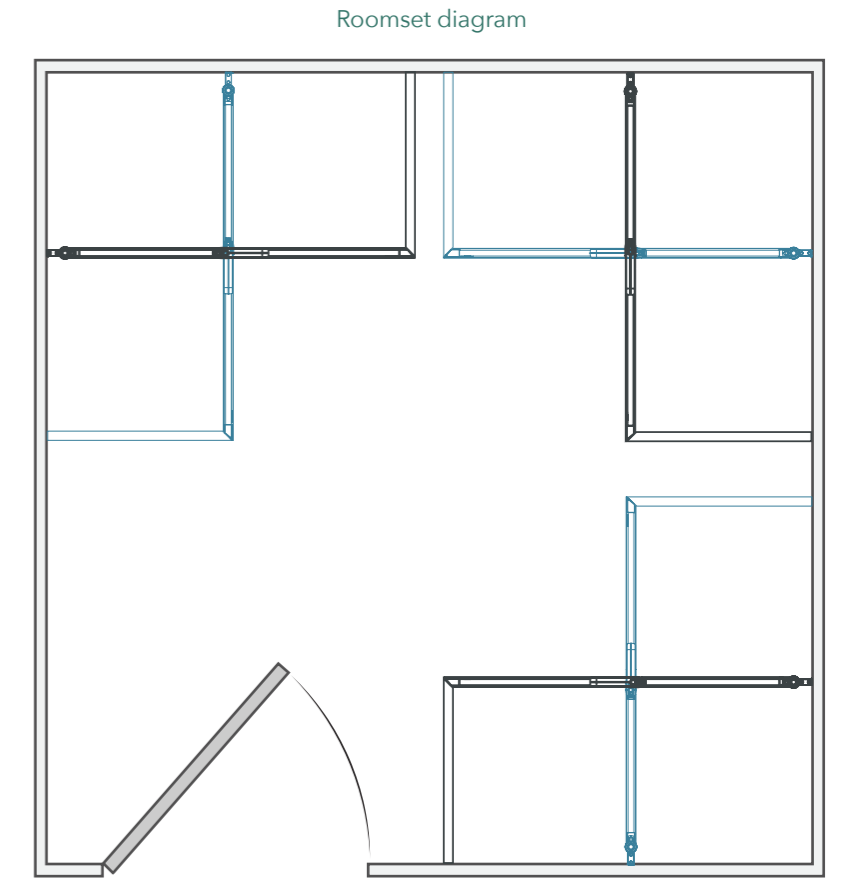
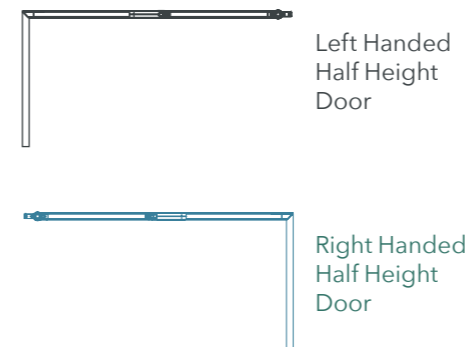

## Half Height Door - sizing

Standard Half Height Doors are manufactured to allow for wall tile, or shower board finishes as standard. Do not make extra deductions for wall finishes when taking measurements.

**Special / Bespoke**  
If the dimensions provided upon ordering are 'Tile-to-Tile', 10mm is added per door to ensure maximum size ordered.

## Half Height Door - measuring

Elevate have been designed to feature a 25mm downward compensation to make allowance for untrue walls.

Please check all measurements prior to ordering, and contact our Technical Team if you have any queries.

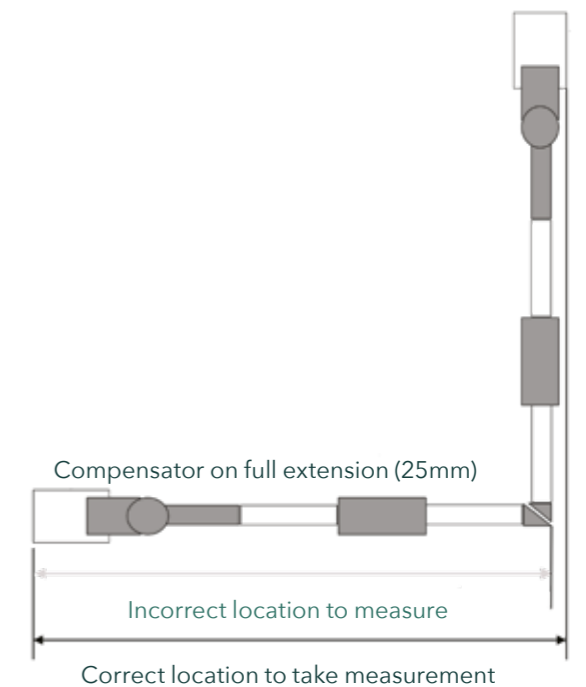

For advice and guidance on bespoke options, please call our Technical team on 01460 256080



Lifetime Guarantee

# Supreme Glass Screens

Supreme Glass Shower Panels offer a luxurious appearance, whilst also providing practical support and ease of entry to the shower.

## Practical & Personal

## Form & Function

The telescopic pole not only provides a rigid and stylish securing point for the glass but acts as an integrated grab rail for discreet assistance.

### Key Benefits

- Available in 5 sizes
- Two install options
- CE compliant to BS EN 14428
- Coving extension profile available for vinyl floors
- No breaching of the floor required to fix the pole, protects against water ingress
- Pre-drilled wall profile
- Push in glass profile with 20mm adjustment
- Coving extension profile available
- No drilling required to secure the pole to the floor
- Suitable for use on level-access wetroom floor
- All fixings and seals provided
- Fully detailed instructions supplied
- Lifetime guarantee

# Supreme Glass Screens

Supreme Glass Shower Panels offer a luxurious appearance, whilst also providing practical support and ease of entry to the shower, fitted on a wetroom floor.

They are supported by a polished aluminium column, which can be ceiling fixed, or wall braced, which offers the option of hanging a shower curtain to provide further screening. The column is secured to the floor with TigerFix, an innovative new fitting that requires no screws and can also be easily removed.

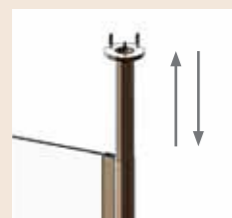

### Telescopic pole

Simply adjust to height, twist, lock & secure. No screws or cutting required

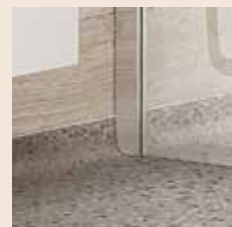

### Coving profile

For areas where a coved vinyl floor has been installed you will need to order a coving extension profile  
Code: ICEP2000



### TigerFix

An innovative adhesive solution that allows easy install without the need for drilling or fixing. It can also be easily removed without causing any damage

Luxury combined with practicality

2000mm high, plain glass with Aqua-Shield Easy Clean Finish

### Telescopic pole

Can also be attached by wall braced fixing

Rigid strong support

8mm toughened safety glass

Shower Panels are available in 5 sizes

700mm, 800mm, 900mm, 1000mm and 1200mm wide

Coving profile

TigerFix







Floor to ceiling with plain glass

Code	Size	Price Ex. Vat	Price inc. VAT
ISS70CUC	700mm wide	£529.58	£635.50
ISS80CUC	800mm wide	£529.58	£635.50
ISS90CUC	900mm wide	£529.58	£635.50
ISS10CUC	1000mm wide	£553.66	£664.39
ISS12CUC	1200mm wide	£553.66	£664.39

Please note: For areas where a covered vinyl floor has been installed you will need to order a coving extension profile  
Code: ICEP2000

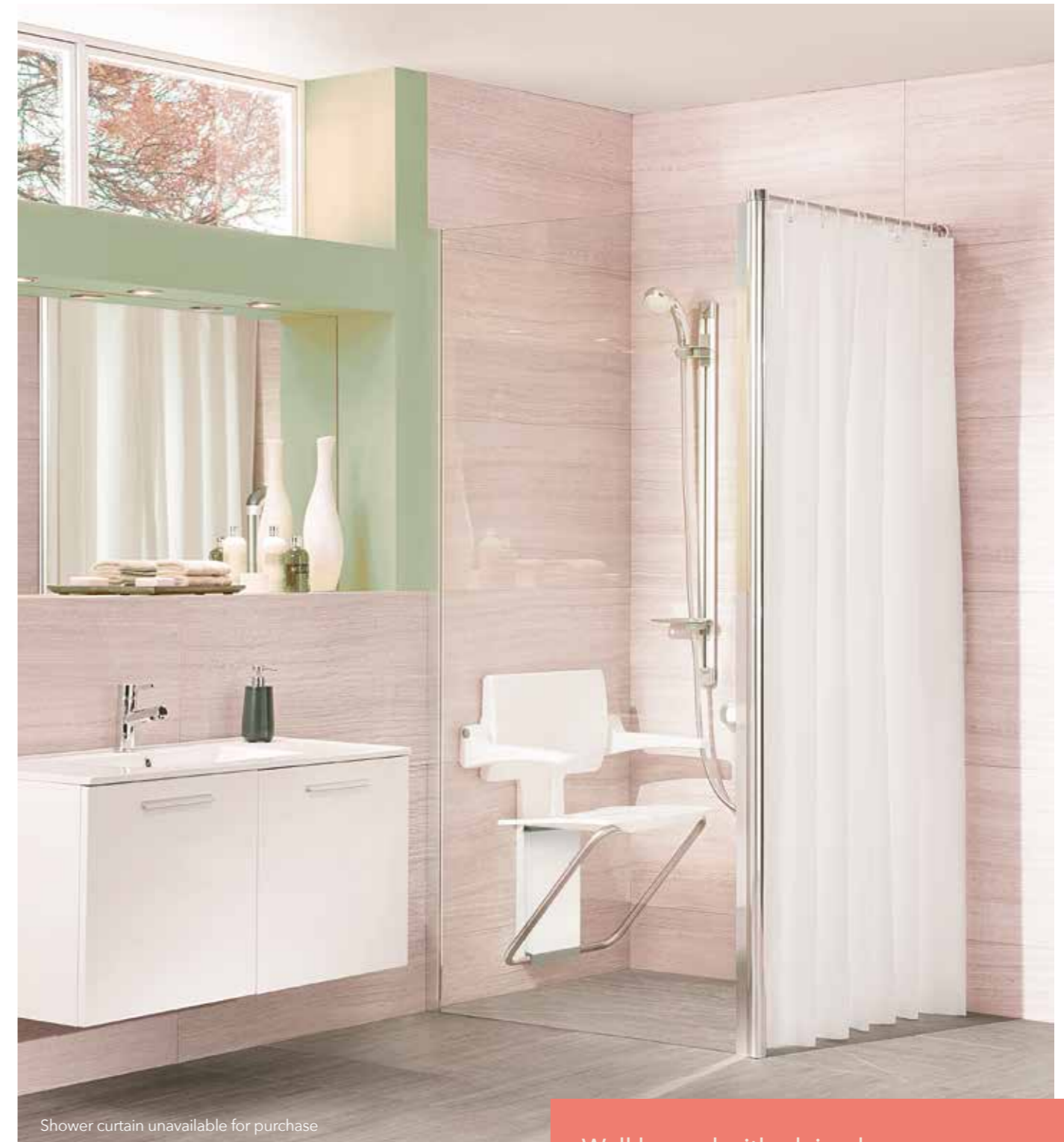

Shower curtain unavailable for purchase

Wall braced with plain glass

Code	Size	Price Ex. Vat	Price inc. VAT
ISSW70CUC	700mm wide	£529.58	£635.50
ISSW80CUC	800mm wide	£529.58	£635.50
ISSW90CUC	900mm wide	£529.58	£635.50
ISSW10CUC	1000mm wide	£553.66	£664.39
ISSW12CUC	1200mm wide	£553.66	£664.39

Please note: For areas where a covered vinyl floor has been installed you will need to order a coving extension profile.  
Code: ICEP2000

# Shower Curtains, Screens and Waste Pumps

With a focus on personal space and ease of use when showering.

**Practical & Personal**

**Form & Function**

Practical additions to your bathroom, keeping water where it belongs.

## Overview

- All shower curtain rails are white and made from powder coated aluminium
- Antibacterial shower curtains available in white or grey
- Window bridging kits provide a simple solution in situations where a window causes an obstruction during curtain rail installations.
- Lightweight portable freestanding shower screens offer an instant solution for shower areas that do not require a permanent fixture
- Shower Waste pump kits can be fitted when gravity drainage is not an option



# Shower Rails

All the rails are white and made from powder coated aluminium and come complete with fixings which includes all brackets, screws, rawl plugs, ceiling support rods and shower curtain hooks and gliders.

Bespoke sizes can be made to order.

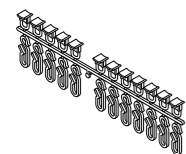

Curved Rails				
Code	Description	Price Ex. Vat	Price inc. VAT	
SRL-9090W	900 x 900 + fixing kit white	£57.05	£68.46	
SRL-120120W	1200 x 1200 + fixing kit white	£61.14	£73.37	
SRL-13090W	1300 x 900 + fixing kit white	£57.53	£69.04	
SRL-15090W	1500 x 900 + fixing kit white	£58.90	£70.68	
SRL-150120W	1500 x 1200 + fixing kit white	£61.27	£73.52	
SRL-18090W	1800 x 900 + fixing kit white	£61.27	£73.52	

Straight Rails				
Code	Description	Price Ex. Vat	Price inc. VAT	
SRS-130W	1.3m + fixing kit white	£54.30	£65.16	
SRS-200W	2.0m + fixing kit white	£56.59	£67.91	
SRS-250W	2.5m + fixing kit white	£57.73	£69.28	

U Rails To be purchased when used in combination with a half height door.				
Code	Description	Price Ex. Vat	Price inc. VAT	
SRU-100100W	1000 x 1000 + fixing kit white (w)900mm x (d)950mm	£83.07	£99.68	
SRU-120120W	1100 x 1150 + fixing kit white (w)1092mm x (d)1140mm	£83.07	£99.68	
SRU-13080W	1300 x 800 + fixing kit white (w)1200mm x (d)750mm	£83.07	£99.68	
SRU-14090W	1400 x 900 + fixing kit white (w)1300mm x (d)850mm	£83.07	£99.68	
SRU-150120W	1500 x 1200 + fixing kit white (w)1400mm x (d)1150mm	£83.07	£99.68	

Standalone U Rails These are to be used when not paired with a half height door. All are provided with white fixing kits as standard door.				
Code	Description	Price Ex. Vat	Price inc. VAT	
SRUT-9090W	(W)900 x (D)900	£83.08	£99.70	
SRUT-100100W	(W) 1000 x (D)1000	£83.08	£99.70	
SRUT-120120W	(W) 1200 x (D)1200	£83.08	£99.70	
SRUT-13080W	(W) 1300 x (D)800	£83.08	£99.70	
SRUT-150120W	(W) 1500 x (D)1200	£83.08	£99.70	

Curved Rail Support Rod The 1.2m trimmable curtain support rod is for installations with high ceilings.				
Code	Description	Price Ex. Vat	Price inc. VAT	
SR-CRSW	1.2m + fixing kit white	£17.71	£21.25	

Spare Curtain rail hooks and gliders for curtain attachment				
Code	Description	Price Ex. Vat	Price inc. VAT	
SR-HGK	Spare Hooks & Gliders	£12.97	£15.56	

# Shower Curtains

- White and grey options
- CIBA antibacterial & fungal protection
- Easy care fabric, specially produced for the bathroom
- 100% Polyester
- Weighted hem to ensure good contact with wet floor
- Machine washable



Shower Curtains				
Code	No of Rings	Width X Depth	Price Ex. Vat	Price inc. VAT
IC1212	8 eyes	(W)1200 x (D)1200mm	£38.11	£45.73
IC181250	12 eyes	(W)1800 x (D)1250mm	£38.11	£45.73
IC1818	12 eyes	(W)1800 x (D)1800mm	£40.04	£48.05
IC1820	12 eyes	(W)1800 x (D)2000mm	£43.48	£52.18
IC1824	12 eyes	(W)1800 x (D)2400mm	£42.62	£51.14
IC2018	14 eyes	(W)2000 x (D)1800mm	£43.48	£52.18
IC2020	14 eyes	(W)2000 x (D)2000mm	£44.77	£53.72
IC2022	14 eyes	(W)2000 X (D)2200mm	£44.77	£53.72
IC2121	12 eyes	(W)2100 X (D)2100mm	£45.08	£54.10
IC2218	14 eyes	(W)2200 x (D)1800mm	£46.11	£55.33
IC2220	14 eyes	(W)2200 x (D)2000mm	£46.11	£55.33
IC1820G	12 eyes	(W)1800 x (D)2000mm - GREY	£46.11	£55.33
IC2020G	12 eyes	(W)2000 x (D)2000mm - GREY	£46.11	£55.33
IC2420G	14 eyes	(W)2400 x (D)2000mm - GREY	£48.54	£58.25

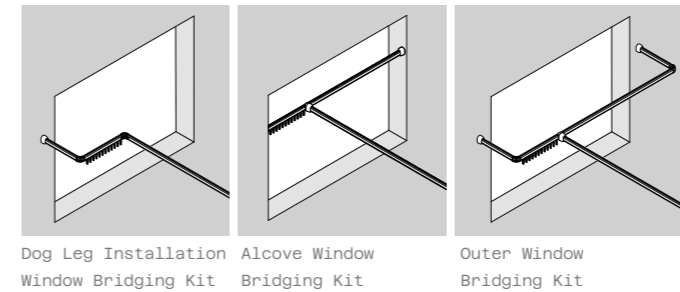

Window Bridging Kit C/W 1.2 DROP CURTAIN WHITE		
Code	Price Ex. Vat	Price inc. VAT
SR-WBKW	£78.94	£94.73

The window bridging kit provides a simple solution in situations where a window causes an obstruction during curtain rail installations.

This kit can be used inside the window opening, outside the window opening and dog leg around the window opening.

**Pack contains:** 1.3m Rail, 1.2m Curtain, 2 corner brackets, pack of hooks and gliders and 2 wall brackets and fittings.



Extension Channel Pack		
Code	Price Ex. Vat	Price inc. VAT
FG-ECP	£62.73	£75.28

The Extension Channel Pack is used to increase the width of a door or fixed panel from the wall. Each extension kit will increase the width by 20mm.

In a corner installation, 2 packs will be necessary and 2 channels can be combined to increase by 40mm.

**Each pack contains:** 1 wall channel, end cap & fittings.

Freestanding Carer Screens			
Code	No of Rings	Price Ex. Vat	Price inc. VAT
FG-IPS1W	2 PANEL 650MM	£330.81	£396.97
FG-IPS2W	2 PANEL 750MM	£402.95	£483.54
FG-IPS3W	2 PANEL 1000MM	£418.15	£501.78
FG-IPS4W	4 PANEL 1250MM	£454.62	£545.54

Lightweight portable freestanding shower screens offer an instant solution for shower areas that do not require a permanent fixture. 750mm high and made from white powder coated aluminium with grey handles and flexible floor seals. All panels are made of semi-transparent and anti-shatter PETG.

# Shower Waste Pump Kits

Shower Waste Pump Kits can be fitted when gravity drainage is not an option. The pump is activated by a flow switch or flow sensor installed in the water supply to the shower.

When the shower is turned on water passes through the flow switch or flow sensor, activating the pump. Alternatively we offer one pump that is controlled directly by a connection to an electric shower, without the need for a flow switch.

All our pumped kits are suitable for wetroom floors or shower trays and include all the fittings needed for a single feed electric shower installation, but please note that for mixer showers you will need a Mixer Shower Conversion Kit and for wetroom floors you will require a pumped shallow waste gully.

	Whale Switch Connect Kit	Whale Instant Match Bluetooth Pump Kit	Whale Instant Match Premium Pump Kit	Whale sense
<b>Code</b>	SWP	SWP/IMBT	SWP/IMPR	SWP/SEN
<b>Warranty</b>	3 years (extended to 5 years with registration)	3 years (extended to 5 years with registration)	3 years (extended to 5 years with registration)	3 years (extended to 5 years with registration)
<b>Bluetooth Compatible</b>	No	Yes with Mira Advance Flex Extra (MIRAADVLEXEXT87)	No	Yes
<b>Noise reduction / Anti-vibration</b>	No	Available as an upgrade	Yes	No
<b>Maximum drainage capacity (litres per min)</b>	Max drainage for mixer = 12l per min Max drainage for electric = 8l per min	Max drainage for electric = 8l per minute	Max drainage for mixer = 12l per min Max drainage for electric = 8l per min	N/A
<b>External switch to run the pump</b>	No	Yes	Yes	Yes
<b>Auto shower-stop</b>	No	Yes (bluetooth operated)	Yes	Yes
<b>Price Ex. Vat</b>	£484.26	£586.95	£813.28	£315.00
<b>Price inc. VAT</b>	£581.11	£704.34	£975.94	£378.00



For advice and support on any of our products, call our Technical team on 01460 256080



## Whale Switch Connect Kit

Code: SWP

This is the original waste pump kit and has been successfully installed in over 150,000 homes across the UK.

### Technical Specification

- Maximum drainage for electric showers 8l/min
- Maximum drainage for mixer showers 12l per minute (additional mixer valve conversion kit required) SWP/MX
- Self priming pump with protective cover
- Low voltage transformer conforms to EN60742
- 12 adjustable settings for electric & mixer showers
- Active link diagnostics
- De-puddling cycle: pump turns on for a brief period, 15 min after shower is turned off
- IP45 Rated



## Whale Instant Match Bluetooth Pump Kit

Code: SWP/IMBT

Designed to be specifically compatible with the Mira Advance Flex Extra using Easy Pair bluetooth technology. A digital signal from the shower automatically adjusts the pump speed in relation to the shower flow rate.

### Technical Specification

- Maximum drainage 8l/min
- Self priming pump with protective cover
- Low voltage transformer conforms to EN60742
- Active Link Diagnostics
- Anti-flood feature with Mira Advance Flex Extra\* - turns shower off if no power on pump
- IP45 rated



## Whale Instant Match Premium Pump Kit

Code: SWP/IMPR

Quiet operation, because the speed is regulated depending on the flow rate of water from the shower. This reduces noise output considerably, whilst also reducing wear on the pump.

### Technical Specification

- Maximum drainage 12l/min
- Automatically adjusts to changes in shower flow rate
- Compensates for changes in voltage from main electric supply
- Self priming pump with protective cover
- Low voltage transformer conforms to EN60742
- IP45 rated



## Whale Sense

Code: SWP/SEN

Whale Sense is a solenoid controller designed for the bathroom which reduces the risk of flooding.

- Automatically shuts off the water supply after a preset period, reducing the risk of a flood.
- Controls the water supply to the shower using solenoids.
- Added protection against flooding/increased water conservation.
- Hands free operation when used with a Passive Infrared Sensor (PIR) to activate the solenoids (may also be operated with a retractive switch).

# impey



Printed with biodegradable laminate:

- ✓ protecting the environment from single use plastics
- ✓ reducing negative impact on the environment.

Whilst every care has been taken to ensure that the information included in this document was accurate at the time of printing, we reserve the right to change product specifications at any time without prior notice.

The photographs reproduced in this document publication are within the constraints of the printing process and are not to be used for matching purposes. All photographs are used for approximate representation only and may not show the actual products on offer. Errors and Omissions Excepted.

Full terms and conditions available at [www.impeyshowers.com](http://www.impeyshowers.com)

01460 256080

[www.impeyshowers.com](http://www.impeyshowers.com)

[salesorders@impeyshowers.com](mailto:salesorders@impeyshowers.com)

**Impey**

Conquest Business Park, Cad Road,  
Ilton, Somerset, TA19 9EA

@impeyshowers

